

720 (Beijing) Health iTech Co., Ltd.

TEST REPORT

SCOPE OF WORK

EMC TESTING—KJ350F-C350-A

REPORT NUMBER

210420047GZU-001

ISSUE DATE

15- June -2021

[REVISED DATE]

[-----]

PAGES

45

DOCUMENT CONTROL NUMBER

EN 55014:2017+A11:2020 (With electronics)-a
© 2017 INTERTEK



TEST REPORT

Applicant Name & Address : 720 (Beijing) Health iTech Co., Ltd.
No 101-42/101-43 (Dongsheng district), 9th Floor, No 1 Building,
No 8th, Heiquan Road, Haidian District, Beijing City, China.
Manufacturing Site : Same as Applicant
Intertek Report No: : 210420047GZU-001

Test standards

EN 55014-1:2017+A11:2020
EN IEC 61000-3-2:2019
EN 61000-3-3:2013+A1:2019
EN 55014-2:2015

Sample Description

Product : Air Purifier
Model No. : KJ350F-C350-A
Electrical Rating : AC100V-240V, 50/60Hz, 41W, Class II
Serial No. : Not Labeled
Date Received : 20 April 2021
Date Test : 22 April 2021-13 June 2021
Conducted

Prepared and Checked By



Elena Lei
Engineer

Approved By:



Strong Yao
Manager

This report is for the exclusive use of Intertek's Client and is provided pursuant to the agreement between Intertek and its Client. Intertek's responsibility and liability are limited to the terms and conditions of the agreement. Intertek assumes no liability to any party, other than to the Client in accordance with the agreement, for any loss, expense or damage occasioned by the use of this report. Only the Client is authorized to permit copying or distribution of this report and then only in its entirety. Any use of the Intertek name or one of its marks for the sale or advertisement of the tested material, product or service must first be approved in writing by Intertek. The observations and test results in this report are relevant only to the sample tested. This report by itself does not imply that the material, product, or service is or has ever been under an Intertek certification program.

Intertek Testing Services Shenzhen Ltd. Guangzhou Branch
Room 02, & 101/E201/E301/E401/E501/E601/E701/E801 of Room 01 1-8/F., No. 7-2. Caipin Road, Science City, GETDD,
Guangzhou, Guangdong, China

TEST REPORT

CONTENT

TEST REPORT 1

CONTENT 3

1. TEST RESULTS SUMMARY 5

2. EMC RESULTS CONCLUSION..... 6

3. LABORATORY MEASUREMENTS..... 7

4. EQUIPMENT USED DURING TEST 8

5. EMI TEST..... 11

5.1 EN 55014-1 CONTINUOUS CONDUCTED DISTURBANCE VOLTAGE TEST 11

5.1.1 *Block Diagram of Test Setup* 11

5.1.2 *Test Setup and Procedure*..... 11

5.1.3 *Test Data and curve*..... 12

5.2 EN 55014-1 CONDUCTED COMMON MODE (ASYMMETRIC MODE) DISTURBANCE AT WIRED NETWORK PORTS 14

5.3 EN 55014-1 DISCONTINUOUS CONDUCTED DISTURBANCE VOLTAGE 14

5.3.1 *Block Diagram of Test Setup* 14

5.3.2 *Test Setup and Procedure*..... 14

5.3.3 *Test Data and curve*..... 15

5.4 EN 55014-1 RADIATED DISTURBANCE (9 KHZ-30 MHZ)- MAGNETIC FIELD INDUCED CURRENT METHOD 15

5.5 RADIATED DISTURBANCE (9 KHZ-30 MHZ)- MAGNETIC FIELD STRENGTH METHOD 15

5.6 EN 55014-1 RADIATED DISTURBANCE POWER 16

5.6.1 *Block Diagram of Test Setup* 16

5.6.2 *Test Setup and Procedure*..... 16

5.6.3 *Test Data and curve*..... 17

5.7 EN 55014-1 RADIATED DISTURBANCE(30MHZ-1000MHZ) 18

6. HARMONICS OF CURRENT 18

6.1 BLOCK DIAGRAM OF TEST SETUP 18

6.2 TEST SETUP AND PROCEDURE..... 18

6.3 TEST DATA 18

7. FLICKER..... 19

7.1 BLOCK DIAGRAM OF TEST SETUP 19

7.2 TEST SETUP AND PROCEDURE..... 19

7.2.1 *Definition*..... 19

7.2.2 *Test condition* 19

8. EMS TEST..... 20

8.1 EN 61000-4-2(PURSUANT TO EN 55014-2) ELECTROSTATIC DISCHARGE IMMUNITY 21

8.1.1 *Block Diagram of Test Setup* 21

8.1.2 *Test Setup and Procedure*..... 21

8.1.3 *Test Result*..... 23

TEST REPORT

8.2	EN 61000-4-6(PURSUANT TO EN 55014-2) INJECTED CURRENT (0.15 MHZ TO 230 MHZ)	24
8.2.1	<i>Block Diagram of Test Setup</i>	24
8.2.2	<i>Test Setup and Procedure</i>	24
8.2.3	<i>Test Result</i>	24
8.3	EN 61000-4-4(PURSUANT TO EN 55014-2) ELECTRICAL FAST TRANSIENT/BURST	25
8.3.1	<i>Block Diagram of Test Setup</i>	25
8.3.2	<i>Test Setup and Procedure</i>	25
8.3.3	<i>Test Result</i>	25
8.4	EN 61000-4-5(PURSUANT TO EN 55014-2) SURGE IMMUNITY	26
8.4.1	<i>Block Diagram of Test Setup</i>	26
8.4.2	<i>Test Setup and Procedure</i>	26
8.4.3	<i>Test Result</i>	26
8.5	EN 61000-4-11(PURSUANT TO EN 55014-2) VOLTAGE DIPS AND INTERRUPTIONS	27
8.5.1	<i>Block Diagram of Test Setup</i>	27
8.5.2	<i>Test Setup and Procedure</i>	27
8.5.3	<i>Test Result</i>	27
8.6	EN 61000-4-3(PURSUANT TO EN 55014-2) RADIATED ELECTROMAGNETIC FIELD IMMUNITY	28
8.6.1	<i>Block Diagram of Test Setup</i>	28
8.6.2	<i>Test Setup and Procedure</i>	29
8.6.3	<i>Test Result</i>	29
9.	APPENDIX I - PHOTOS OF TEST SETUP	30
10.	APPENDIX II – PHOTOS OF EUT	34

TEST REPORT

1. TEST RESULTS SUMMARY

Test Item	Standard	Result
Continuous conducted disturbance voltage	EN 55014-1:2017+A11:2020	Pass
Conducted Disturbance at wired network ports	EN 55014-1:2017+A11:2020	N/A
Discontinuous conducted disturbance voltage	EN 55014-1:2017+A11:2020	Pass
Radiated disturbance(9kHz-30MHz)	EN 55014-1:2017+A11:2020	N/A
Radiated disturbance power	EN 55014-1:2017+A11:2020	Pass
Radiated disturbance(30MHz-1000MHz)	EN 55014-1:2017+A11:2020	N/A
Harmonic of current	EN IEC 61000-3-2:2019	Pass
Flicker	EN 61000-3-3:2013+A1:2019	Pass
ESD immunity	EN 55014-2: 2015 Reference: EN 61000-4-2:2009	Pass
Radiated EM field immunity	EN 55014-2:2015 Reference: EN 61000-4-3:2006+A1:2008+A2:2010	Pass
EFT immunity	EN 55014-2:2015 Reference: EN 61000-4-4:2012	Pass
Surge immunity	EN 55014-2:2015 Reference: EN 61000-4-5:2014	Pass
Inject current immunity	EN 55014-2:2015 Reference: EN 61000-4-6:2014	Pass
Voltage dips and interruption immunity	EN 55014-2:2015 Reference: EN 61000-4-11:2004	Pass

Remark:

1. The symbol "N/A" in above table means Not Applicable.
2. When determining the test results, measurement uncertainty of tests has been considered.

TEST REPORT

2. EMC RESULTS CONCLUSION

RE: EMC Testing Pursuant to EMC Directive 2014/30/EU Performed on the Air Purifier, Models: KJ350F-C350-A.

We tested the Air Purifier, Models: KJ350F-C350-A. to determine if it was in compliance with the relevant EN standards as marked on the Test Results Summary. We found that the unit met the requirements of EN 55014-1, EN 61000-3-2, EN 61000-3-3, EN 55014-2 (EN 61000-4-2), EN 55014-2 (EN 61000-4-4), EN 55014-2 (EN 61000-4-6), EN 55014-2 (EN 61000-4-5), & EN 55014-2 (EN 61000-4-11) standards when tested as received. The worst case's test data was presented in this test report.

Remark:

They all have a motor of the same type.

The production units are required to conform to the initial sample as received when the units are placed on the market.

TEST REPORT

3. LABORATORY MEASUREMENTS

Configuration Information

Support Equipment: N/A

Rated Voltage and frequency under test: 230 V; 50/60Hz Hz

Condition of Environment: Temperature: 22~28°C
Relative Humidity:35~60%
Atmosphere Pressure:86~106kPa

Notes:

1. The EMI measurements had been made in the operating mode produced the largest emission in the frequency band being investigated consistent with normal applications. An attempt had been made to maximize the emission by varying the configuration of the EUT.
2. The EMS measurements had been made in the frequency bands being investigated, with the EUT in the most susceptible operating mode consistent with normal applications. The configuration of the test sample had been varied to achieve maximum susceptibility.
3. Test Location:
Intertek Testing Services Shenzhen Ltd. Guangzhou Branch
All tests were performed at:
Room 02, & 101/E201/E301/E401/E501/E601/E701/E801 of Room 01 1-8/F., No. 7-2. Caipin Road, Science City, GETDD, Guangzhou, Guangdong, China
Except Radiated Disturbance and Radiated Susceptibility were performed at:
Room102/104, No 203, KeZhu Road, Science City, GETDD Guangzhou, China

4. Measurement Uncertainty

No.	Item	Measurement Uncertainty
1	Conducted Emission (9 kHz-150 kHz)	2.79 dB
2	Conducted Emission (150 kHz-30 MHz)	2.55 dB
3	Disturbance Power (30 MHz-300 MHz)	3.04 dB
4	Radiated Emission (30 MHz-1 GHz)	4.80 dB
5	Radiated Emission (1 GHz-6 GHz)	4.97 dB
6	Radiated Emission (6 GHz-18 GHz)	4.89 dB

The measurement uncertainty describes the overall uncertainty of the given measured value during the operation of the EUT.

Measurement uncertainty is calculated in accordance with CISPR16-4-2:2011+A1:2014 +A2:2018.

The measurement uncertainty is given with a confidence of 95%, k=2.

Determination of the test conclusion is based on IEC Guide 115 in consideration of measurement uncertainty.

TEST REPORT

4. EQUIPMENT USED DURING TEST

Conducted Disturbance-Mains Terminal (2)

Equipment No.	Equipment	Model	Manufacturer	Calibration Interval
EM080-05	EMI receiver	ESCI	R&S	1Y
EM006-05	LISN	ENV216	R&S	1Y
SA047-112	Digital Temperature-Humidity Recorder	RS210	YIJIE	1Y
EM004-04	EMC shield Room	8m×3m×3m	Zhongyu	1Y

Click (2)

Equipment No.	Equipment	Model	Manufacturer	Calibration Interval
EM008-02	Click Tester	DDA55	AFJ	1Y
EM008-02-01	Switch Box	SW04/32 CL55C	AFJ	1Y
EM006-04	LISN	ESH2-Z5	R&S	1Y
EM032-02	LISN	NSLK8128	SCHWARZBECK	1Y
SA047-111	Digital Temperature-Humidity Recorder	RS210	YIJIE	1Y
EM004-03	EMC shield Room	8m×4m×3m	Zhongyu	1Y

Disturbance Power

Equipment No.	Equipment	Model	Manufacturer	Calibration Interval
EM080-05	EMI receiver	ESCI	R&S	1Y
EM081-04	Absorb Power Clamp	MDS-21	R&S	1Y
SA047-112	Digital Temperature-Humidity Recorder	RS210	YIJIE	1Y
EM004-04	EMC shield Room	8m×3m×3m	Zhongyu	1Y

Electrostatic Discharge (1)

Equipment No.	Equipment	Model	Manufacturer	Calibration Interval
EM077-04	ESD Simulator	NSG437	TESEQ	1Y
SA047-143	Digital Temperature-Humidity Recorder	AW5145Y	ASAIR	1Y

Electrical Fast Transient/Burst (2)

Equipment No.	Equipment	Model	Manufacturer	Calibration Interval
EM005-10	EFT Generator	NSG3025	TESEQ	1Y
EM005-10-01	Capacitive Coupling Clamp	CDN8014	TESEQ	1Y
SA047-140	Digital Temperature-Humidity Recorder	AW5145Y	ASAIR	1Y

Surge (3)

TEST REPORT

Equipment No.	Equipment	Model	Manufacturer	Calibration Interval
EM005-09	Surge/DIP Generator	NSG3040	TESEQ	1Y
SA047-140	Digital Temperature-Humidity Recorder	AW5145Y	ASAIR	1Y

Conducted Susceptibility (1)

Equipment No.	Equipment	Model	Manufacturer	Calibration Interval
EM046-04	Power Amplifier	CBA230M-080	TESEQ	1Y
EM084-02	Signal generator	SML02	R&S	1Y
EM003-01-04	Coupling&Decoupling Network	CDN M2+M3	Dr.Hubert GmbH	1Y
EM003-01-05	Attenuator	6dB	Dr.Hubert GmbH	1Y
EM019-01-01	Current Electromagnetic injection clamp	KEMZ801S	Teseq GmbH	1Y
EM019-03	Current Clamp	CIP 9136A	Teseq GmbH	1Y
SA047-140	Digital Temperature-Humidity Recorder	AW5145Y	ASAIR	1Y

Voltage Dips and Interruptions (2)

Equipment No.	Equipment	Model	Manufacturer	Calibration Interval
EM005-09	Surge/DIP Generator	NSG3040	TESEQ	1Y
EM005-09-01	Voltage Regulator	INA6501	TESEQ	1Y
SA047-140	Digital Temperature-Humidity Recorder	AW5145Y	ASAIR	1Y

Radiated Susceptibility

Equipment No.	Equipment	Model	Manufacturer	Calibration Interval
EM030-04	3m Semi-Anechoic Chamber	9x6x6 m ³	ETS LINDGREN	1Y
EM031-01	Signal generator	SMB100A	R&S	1Y
EM086-11	Power meter	NRP2	R&S	1Y
EM086-11-01	Power sensor	NRP-Z91	R&S	1Y
EM046-01	Power Amplifier	80RF1000-300	MILMEGA	1Y
EM046-03	Power Amplifier	AS0860-75-45	MILMEGA	1Y
EM061-05	Log. - Per. Broadband Antenna	VULP 9118 E	SCHWARZBECK	2Y
EM061-07	Stacked Log.-Per. Broadband Antenna	STLP 9149	SCHWARZBECK	2Y
EM034-01	Open Switch and Control Platform	OSP120/1505.3009K12	R&S	1Y
EM045-01-01	EMC32 software (RE/RS)	V10.01.00	R&S	1Y
SA047-118	Digital Temperature-Humidity Recorder	RS210	YIJIE	1Y

TEST REPORT

Detail of the equipment calibration due date:

Equipment No.	Cal. Due date (DD-MM-YYYY)
Conducted Disturbance-Mains Terminal (1)	
EM080-05	19/07/2021
EM006-05	06/06/2022
SA047-112	16/11/2021
EM004-04	21/01/2022
Conducted Disturbance-Mains Terminal (2)	
EM031-04	07/01/2022
EM006-06	06/09/2021
SA047-111	16/11/2021
EM004-03	21/01/2022
EM031-04-01	N/A
Conducted Disturbance-Load and Control Terminal (1)	
EM080-05	19/07/2021
EM080-05-01	06/09/2021
SA047-112	16/11/2021
EM004-04	21/01/2022
Conducted Disturbance-Load and Control Terminal (2)	
EM080-05	19/07/2021
EM005-06-01	06/09/2021
SA047-112	16/11/2021
EM004-04	21/01/2022
Conducted Disturbance-Telecom Terminal	
EM080-05	19/07/2021
EM011-05	05/04/2022
EM011-06	05/04/2022
EM006-06	06/09/2021
SA047-112	16/11/2021
EM004-04	21/01/2022
Conducted Disturbance-Antenna Terminal	
EM031-04	07/01/2022
EM084-02	21/07/2021
EM041-01	05/01/2022
EM041-02	05/01/2022
SA047-111	16/11/2021
EM004-03	21/01/2022
Click (1)	
EM008-01	19/07/2021
EM006-06	06/09/2021
SA047-111	16/11/2021
EM004-03	21/01/2022
Click (2)	
EM008-02	15/11/2021
EM008-02-01	15/11/2021
EM032-02	19/07/2021
SA047-111	16/11/2021
EM004-03	21/01/2022
Disturbance Power	
EM080-05	19/07/2021
EM081-04	09/03/2022
SA047-112	16/11/2021
EM004-04	21/01/2022

Equipment No.	Cal. Due date (DD-MM-YYYY)
Radiated Disturbance (CDN Method)	
EM080-05	19/07/2021
EM003-02	15/11/2021
EM003-03	15/11/2021
EM003-01-05	06/09/2021
EM032-02-01	20/07/2021
EM032-02-02	20/07/2021
SA047-112	16/11/2021
EM004-04	21/01/2022
Radiated electromagnetic disturbances (9 kHz-30 MHz)	
EM031-04	07/01/2022
EM061-04	07/03/2022
SA047-111	16/11/2021
EM004-03	21/01/2022
Radiated Disturbance (9 kHz-30 MHz)	
EM030-04	06/04/2022
EM031-02	16/10/2021
EM011-04	18/06/2021
EM031-02-01	05/04/2022
SA047-118	21/07/2021
EM045-01-01	N/A
Radiated Disturbance (30 MHz-1 GHz)	
EM030-04	06/04/2022
EM031-02	16/10/2021
EM033-01	18/09/2021
EM031-02-01	05/04/2022
EM036-01	21/07/2021
SA047-118	21/07/2021
EM045-01-01	N/A
Radiated Disturbance (1-18 GHz)	
EM030-04	06/04/2022
EM031-02	16/10/2021
EM031-03	06/09/2021
EM033-02	18/06/2021
EM033-02-02	05/04/2022
EM022-03	11/05/2022
SA047-118	21/07/2021
EM045-01-01	N/A
Harmonic Currents and Flicker (1)	
EM001-02	15/11/2021
SA047-111	16/11/2021
Harmonic Currents and Flicker (2)	
EM001-03	11/09/2021
EM001-03-01	11/09/2021
SA047-140	05/01/2022
EMF	
EM007-03	25/02/2022
SA047-112	16/11/2021
Induced Current Density (20 kHz-10 MHz)	
EM031-04	07/01/2022
EM007-02	07/01/2022
SA047-111	16/11/2021

Equipment No.	Cal. Due date (DD-MM-YYYY)
Electrostatic Discharge (1)	
EM077-04	08/04/2022
SA047-133	16/03/2022
Electrostatic Discharge (2)	
EM077-02	08/05/2021
SA047-133	16/03/2022
Electrical Fast Transient/Burst (1)	
EM005-12	05/04/2022
EM005-10-01	05/04/2022
SA047-140	05/01/2022
Electrical Fast Transient/Burst (2)	
EM005-10	07/05/2022
EM005-10-01	05/04/2022
SA047-140	05/01/2022
Surge (2)	
EM005-08	19/07/2021
SA047-140	05/01/2022
Surge (3)	
EM005-09	06/06/2022
SA047-140	05/01/2022
Conducted Susceptibility (1)	
EM046-04	10/12/2021
EM084-02	21/07/2021
EM003-01-04	06/09/2021
EM003-01-05	06/09/2021
EM019-01-01	06/09/2021
EM019-03	19/07/2021
SA047-140	05/01/2022
Conducted Susceptibility (2)	
EM019-01	05/04/2022
EM019-01-01	06/09/2021
EM019-01-02	06/09/2021
EM019-01-03	06/09/2021
EM019-03	19/07/2021
SA047-140	05/01/2022
Voltage Dips and Interruptions (2)	
EM005-09	06/06/2022
EM005-09-01	06/06/2022
SA047-140	05/01/2022
Radiated Susceptibility	
EM030-04	06/04/2022
EM031-01	22/07/2021
EM086-11	15/11/2021
EM086-11-01	15/11/2021
EM046-01	07/03/2022
EM046-03	06/09/2021
EM061-05	11/10/2021
EM061-07	11/10/2021
EM034-01	/
EM045-01-01	/
SA047-118	21/07/2021
Power Frequency Magnetic Field	
EM001-03	11/09/2021
EM001-03-02	11/09/2021
SA047-140	05/01/2022
Ring Wave	
EM005-11	05/04/2022
SA047-140	05/01/2022

TEST REPORT

5. EMI TEST

5.1 EN 55014-1 Continuous Conducted Disturbance Voltage Test

Test Result: Pass

5.1.1 Block Diagram of Test Setup

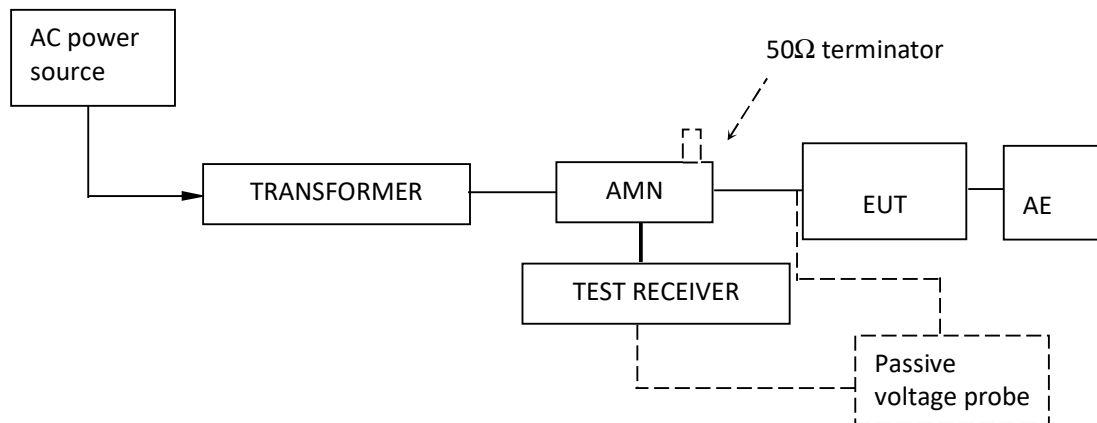

5.1.2 Test Setup and Procedure

The EUT was set to achieve the maximum emission level. The mains terminal disturbance voltage was measured with the EUT in a shielded room. The EUT was connected to AC power source through an Artificial Mains Network which provides a 50Ω linear impedance Artificial hand is used if appropriate (for handheld apparatus). The load/control terminal disturbance voltage was measured with passive voltage probe if appropriate.

The table-top EUT was placed on a 0.4m high non-metallic table above earthed ground plane (Ground Reference Plane). And for floor standing EUT, was placed on a 0.1m high non-metallic supported on GRP. The EUT keeps a distance of at least 0.8m from any other of the metallic surface. The Artificial Mains Network is situated at a distance of 0.8m from the EUT.

During the test, mains lead of EUT excess 0.8m was folded back and forth parallel to the lead so as to form a horizontal bundle with a length between 0.3m and 0.4m.

The bandwidth of test receiver was set at 9 kHz. The frequency range from 150 kHz to 30MHz was checked.

When measurements of disturbance are being made, the appliance shall be operated under the conditions defined in Annex A.

TEST REPORT

5.1.3 Test Data and curve

At mains terminal:
Tested Wire: Live

Operation Mode: Work at maximum power

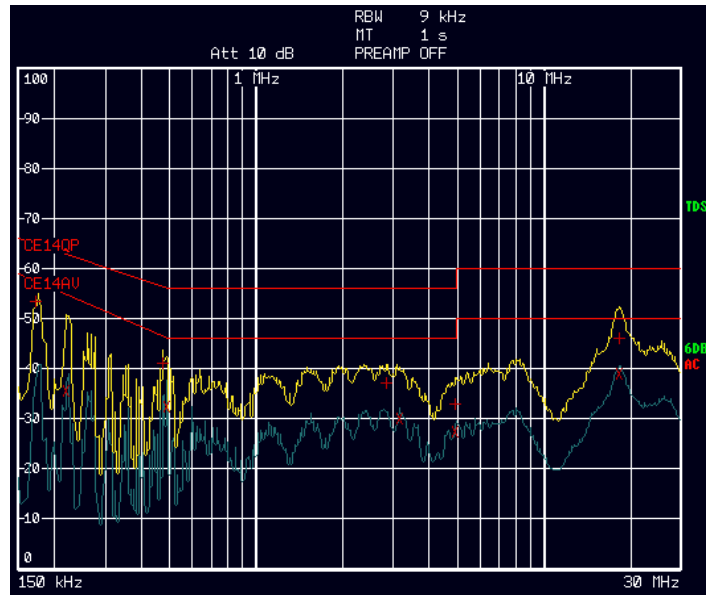

EDIT PEAK LIST (Final Measurement Results)				
TRACE		FREQUENCY	LEVEL dBμV	DELTA LIMIT dB
Trace1:	CE14QP			
Trace2:	CE14AU			
Trace3:	---			
1	Quasi Peak	174 kHz	53.44 L1	-11.32
2	Average	222 kHz	35.57 L1	-19.19
1	Quasi Peak	474 kHz	41.19 L1	-15.24
2	Average	486 kHz	32.30 L1	-13.99
1	Quasi Peak	2.842 MHz	37.14 L1	-18.85
2	Average	3.158 MHz	30.01 L1	-15.98
1	Quasi Peak	4.93 MHz	32.98 L1	-23.02
2	Average	4.974 MHz	27.36 L1	-18.64
1	Quasi Peak	18.406 MHz	46.16 L1	-13.83
2	Average	18.506 MHz	38.90 L1	-11.09

Remark:

1. Corr. (dB) = LISN Factor (dB) + Cable Loss (dB)
2. Level (dBμV) = Corr. (dB) + Read Level (dBμV)
3. Delta Limit (dB) = Level (dBμV)-Limit (dBμV)

TEST REPORT

Tested Wire: Neutral

Operation Mode: Work at maximum power

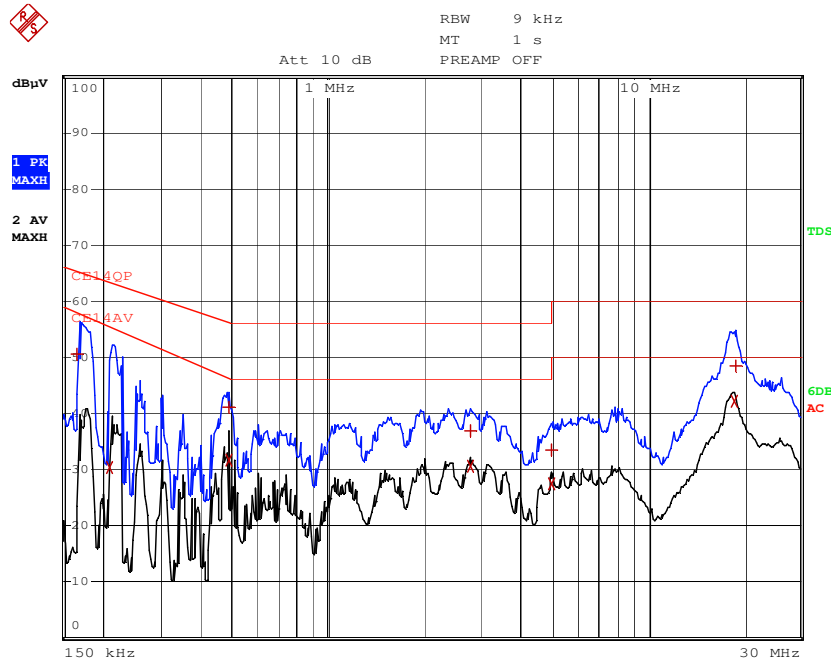

EDIT PEAK LIST (Final Measurement Results)					
TRACE		FREQUENCY	LEVEL		DELTA LIMIT
Trace1:	CE14QP				
Trace2:	CE14AV				
Trace3:	---				
TRACE		FREQUENCY	LEVEL		DELTA LIMIT
1	Quasi Peak	166 kHz	50.58	L1	-14.57
2	Average	210 kHz	30.39	L1	-24.97
2	Average	486 kHz	31.68	L1	-14.62
1	Quasi Peak	490 kHz	41.03	L1	-15.13
1	Quasi Peak	2.782 MHz	36.90	L1	-19.09
2	Average	2.786 MHz	30.63	L1	-15.36
1	Quasi Peak	4.994 MHz	33.42	L1	-22.58
2	Average	4.994 MHz	27.29	L1	-18.70
2	Average	18.53 MHz	42.03	L1	-7.96
1	Quasi Peak	18.854 MHz	48.32	L1	-11.67

Remark:

1. Corr. (dB) = LISN Factor (dB) + Cable Loss (dB)
2. Level (dBµV) = Corr. (dB) + Read Level (dBµV)
3. Delta Limit (dB) = Level (dBµV)-Limit (dBµV)

At load/control terminal:

Not Applicable.

TEST REPORT

5.2 EN 55014-1 Conducted Common Mode (Asymmetric Mode) Disturbance at wired network Ports

Test Result: Not Applicable

Remark: The test only apply to balanced unscreened ports intended for connection to unscreened balanced pairs

5.3 EN 55014-1 Discontinuous Conducted Disturbance Voltage

Test Result: Pass

5.3.1 Block Diagram of Test Setup

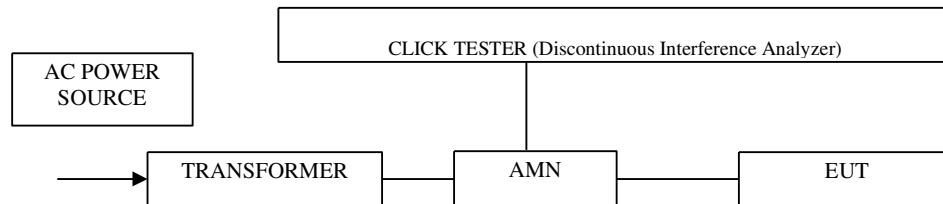

5.3.2 Test Setup and Procedure

The EUT was placed on a 0.8m high non-metallic table in shielded room, the wall of shielded room used as Ground Reference Plane (GRP), and keeps a distance of at least 0.8m from any of the other metallic surface.

The EUT was connected to an artificial mains network and at a distance of 0.8m from it, the excess lead of EUT was bundled with a length of 0.3m to 0.4m parallel to the main lead. The number of counted clicks above the permitted limit for continuous interference and their duration, spacing and rate were measured during the observation time. When relevant, a permitted(relaxed) limit for clicks was calculated and a second measurement was performed. Determination of compliance with the permitted limit according to the upper quartile method was applied. The frequency 150kHz, 500 kHz, 1.4 MHz and 30 MHz was checked.

When measurements of disturbance are being made, the appliance shall be operated under the conditions defined in Annex A.

TEST REPORT

5.3.3 Test Data and curve

Frequency (MHz)	0.15	0.50	1.40	30.00
Permitted limit for continuous interference (dB μ V)	66	56	56	60
Short Clicks [T<10ms]	0	0	0	0
Mid. Clicks [10ms<T<20ms]	0	0	0	0
Long Clicks [T>20ms]	0	0	0	0
Total clicks (number)	0	0	0	0
Switching operation (number)	--			
Factor	--			
Observation time (min.)	120			
Click rate, N	0.00	0.00	0.00	0.00
Value to be added (dB)	--	--	--	--
Counted clicks allowed to exceed the permitted limit (number)	--	--	--	--
Permitted limit for clicks (dB μ V)	--	--	--	--
Counted clicks exceeding the limit (number)	--	--	--	--
Complies with the limit (Pass/Fail)	Pass	Pass	Pass	Pass

The appliance was deemed to comply with the limits if fulfilling the three conditions below:

- the click rate is not more than 5.
- none of the caused clicks has a duration longer than 20 ms.
- 90 % of the caused clicks have a duration less than 10 ms.

5.4 EN 55014-1 Radiated Disturbance (9 kHz-30 MHz)- Magnetic field induced current method

Test Result: Not Applicable

Remark: The test only applies to induction cooking appliances.

5.5 Radiated Disturbance (9 kHz-30 MHz)- Magnetic field strength method

Test Result: Not Applicable

Remark: The test only applies to induction cooking appliances.

TEST REPORT

5.6 EN 55014-1 Radiated Disturbance Power

Test Result: Pass

5.6.1 Block Diagram of Test Setup

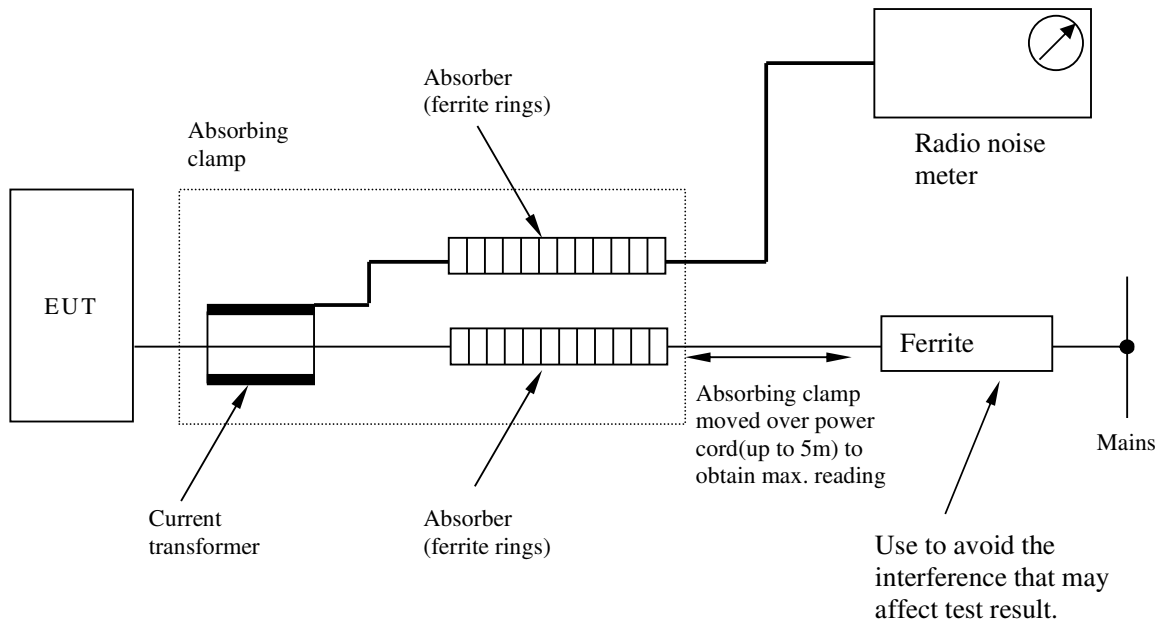

Note: ——— : power line
 ——— : signal line

5.6.2 Test Setup and Procedure

The disturbance power was measured with the EUT in a shielded room. The height of the table shall be $0,1\text{ m} \pm 0,025\text{ m}$ for appliances primarily intended to be positioned on the floor in normal use, and $0,8\text{ m} \pm 0,05\text{ m}$ for other appliances. The EUT was placed on a non-metallic table at least 0.8m from other metallic surface and the mains lead of EUT was extended to about 6m long. The auxiliary lead longer than 0.25m but shorter than twice length of absorbing clamp was extend to twice length of clamp and those longer than twice length was extend to 6 meters.

The absorbing clamp was moved along the lead to obtain maximum disturbance. The EUT was set to achieve the maximum emission level, and for each point which appears a relevant high emission level, the absorbing clamp was moved around the lead to get the maximum disturbance value.

The bandwidth of test receiver was set at 120 kHz. The frequency range from 30MHz to 300MHz was checked.

TEST REPORT

When measurements of disturbance are being made, the appliance shall be operated under the conditions defined in Annex A.

5.6.3 Test Data and curve

Test port: Mains

Operation Mode: Work at maximum power

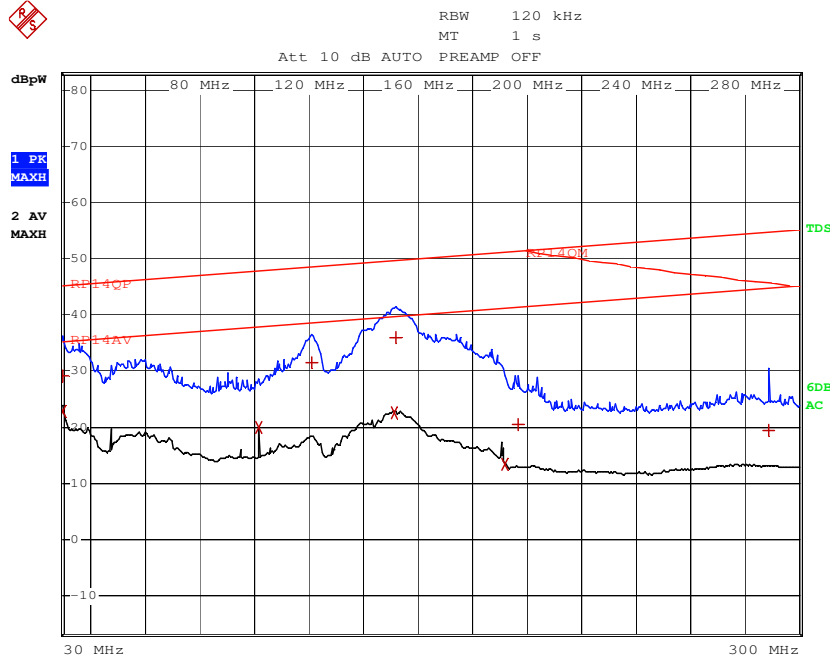

EDIT PEAK LIST (Final Measurement Results)				
TRACE	FREQUENCY	LEVEL dBpW	DELTA	LIMIT dB
Trace1:	RP14QP			
Trace2:	RP14AV			
Trace3:	---			
2 Average	30.04 MHz	22.81 L1	-12.19	
1 Quasi Peak	30.16 MHz	29.08 L1	-15.92	
2 Average	101.68 MHz	19.78 L1	-17.87	
1 Quasi Peak	121.32 MHz	31.33 L1	-17.05	
2 Average	151.24 MHz	22.51 L1	-16.97	
1 Quasi Peak	151.8 MHz	35.94 L1	-13.57	
2 Average	192 MHz	13.38 L1	-27.61	
1 Quasi Peak	196.92 MHz	20.49 L1	-30.68	
1 Quasi Peak	288.72 MHz	19.44 L1	-35.13	

The measurement quasi-peak data of disturbance power is lower than applicable limit reduced by the margin (0 to 10dB) at frequency range 200 to 300 MHz and the maximum clock frequency is less than 30MHz

TEST REPORT

5.7 EN 55014-1 Radiated Disturbance(30MHz-1000MHz)

Test Result: Not Applicable

Remark:

Radiated disturbance shall not be conducted, if the measurement quasi-peak data of disturbance power is lower than applicable limit reduced by the margin (0 to 10dB) at frequency range 200 to 300 MHz and the maximum clock frequency is less than 30MHz,.

6. Harmonics of current

Test Result: Pass

6.1 Block Diagram of Test Setup

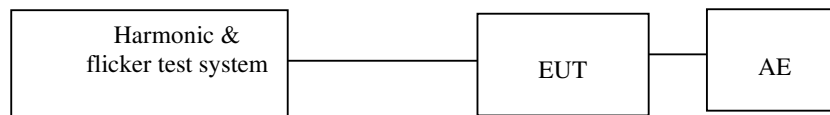

6.2 Test Setup and Procedure

Harmonics of the fundamental current were measured up to 40 order harmonics using a digital power meter with an analogue output and frequency analyser which was integrated in the harmonic & flicker test system. The measurements were carried out under steady conditions.

6.3 Test Data

This product is not defined as lighting equipment, and rated power is less than 75W, therefore, no limit applies according to EN 61000-3-2.

TEST REPORT

7. Flicker

Test Result: Pass

7.1 Block Diagram of Test Setup

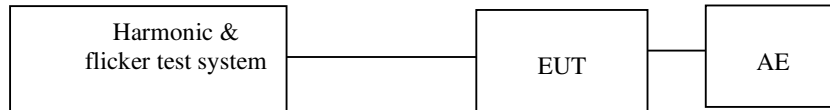

7.2 Test Setup and Procedure

7.2.1 Definition

Flicker:	impression of unsteadiness of visual sensation induced by a lighting stimulus whose luminance or spectral distribution fluctuates with time.
Pst:	Short-term flicker indicator The flicker severity evaluated over a short period (in minutes); Pst=1 is the conventional threshold of irritability
Plt:	long-term flicker indicator; the flicker severity evaluated over a long period (a few hours). Using successive Pst value.
dc:	the relative steady-state voltage change
dmax:	the maximum relative voltage change
d(t):	the value during a voltage change

7.2.2 Test condition

The EUT was set to produce the most unfavourable sequence of voltage changes.

This product is unlikely to produce significant voltage fluctuations and flicker by examination of the circuit diagram and specification of it. Therefore, it is deemed to fulfill the relevant standard without testing.

TEST REPORT

8. EMS TEST

Performance Criteria:

- Criterion A: The apparatus shall continue to operate as intended during the test. No degradation of performance or loss of function is allowed below a performance level (or permission loss of performance) specified by the manufacturer, when the apparatus is used as intended. If the minimum performance level or the permissible performance loss is not specified by the manufacturer, then either of these may be derived from the product description and documentation and from what the user may reasonably expect from the apparatus if used as intended.
- Criterion B: The apparatus shall continue to operate as intended after the test. No degradation of performance or loss of function is allowed below a performance level (or permission loss of performance) specified by the manufacturer, when the apparatus is used as intended. During the test, degradation of performance is allowed, however, no change of actual operating state or stored data is allowed. If the minimum performance level or the permissible performance loss is not specified by the manufacturer, then either of these may be derived from the product description, and documentation, and from what the user may reasonably expect from the apparatus if used as intended.
- Criterion C: Temporary loss of function is allowed, provided the function is self-recoverable or can be restored by the operation of the controls, or by any operation specified in the instruction for use.

Operation mode of EMS test:

Test Item	Operation mode
ESD immunity	Work at Middle power
Radiated EM field immunity	
EFT immunity	
Surge immunity	
Inject current immunity	
Voltage dips and interruption immunity	

Note: "N/A" means Not Applicable in below text.

TEST REPORT

8.1 EN 61000-4-2(Pursuant to EN 55014-2) Electrostatic Discharge Immunity

Performance criterion: B

Test Result: Pass

8.1.1 Block Diagram of Test Setup

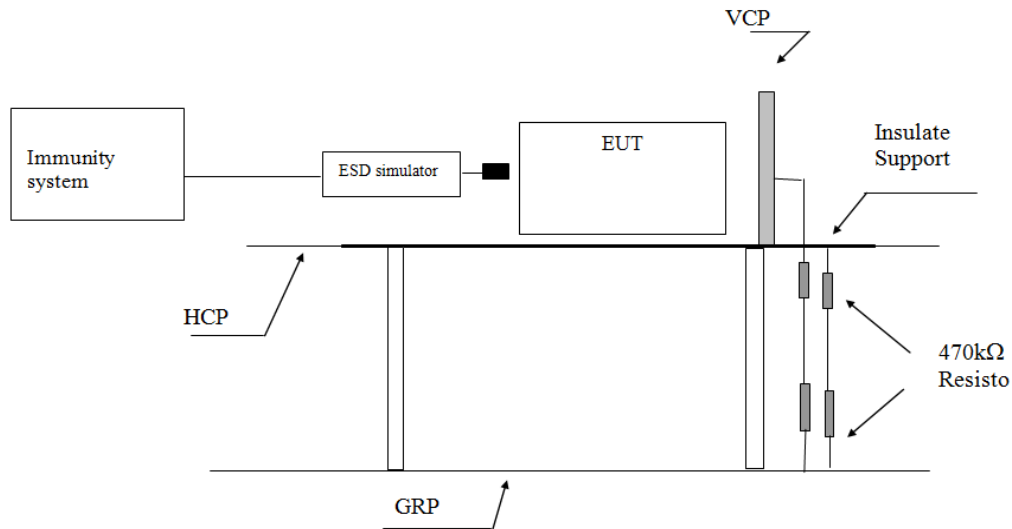

Note: HCP means Horizontal Coupling Plane,

VCP means Vertical Coupling Plane

GRP means Ground Reference Plane

8.1.2 Test Setup and Procedure

The EUT was put on a 0.8m high wooden table 0.1m high for floor standing equipment standing on the ground reference plane (GRP) 3m by 2m in size, made by iron 1.0 mm thick.

A horizontal coupling plane(HCP) 1.6m by 0.8m in size was placed on the table, and the EUT with its cables were isolated from the HCP by an insulating support thick than 0.5mm. The VCP 0.5m by 0.5m in size & HCP were constructed from the same material type & thickness as that of the GRP, and connected to the GRP via a 470kΩ resistor at each end.

The distance between EUT and any of the other metallic surface excepted the GRP, HCP & VCP was greater than 1m.

The EUT was arranged and connected according to its functional requirements.

Direct static electricity discharges were applied only to those points and surface which were accessible to personnel during normal usage.

TEST REPORT

On each preselected points 10 times of each polarity single discharge were applied. The time interval between successive single discharges was at least 1s.

The ESD generator was held perpendicular to the surface to which the discharge was applied. The discharge return cable of the generator was kept at a distance of 0.2m whilst the discharge was being applied. During the contact discharges, the tip of the discharge electrode was touched the EUT before the discharge switch was operated. During the air discharges, the round discharge tip of the discharge electrode was approached as fast as possible to touch the EUT.

Indirect discharge was conducted to objects placed near the EUT, simulated by applying the discharges of the ESD generator to a coupling plane, in the contact discharge mode.

After each discharge, the ESD generator was removed from the EUT, the generator was then retriggered for a new single discharge. For ungrounded product, a grounded carbon fibre brush with bleeder resistors ($2 \times 470 \text{ k}\Omega$) in the grounding cable was used after each discharge to remove remnant electrostatic voltage.

For air discharge, a minimum of 10 single air discharges were applied to the selected test point for each such area.

TEST REPORT

8.1.3 Test Result

Direct Application of ESD

Direct Contact Discharge

Applied Voltage (kV)	No. of Discharge for each point	Result (Pursuant to EN 55014-2)	Discharged Points
4	20	N/A	Accessible metal parts of the EUT Conductive substrate with coating which is not declared to be insulating

Direct Air Discharge

Applied Voltage (kV)	No. of Discharge for each point	Result (Pursuant to EN 55014-2)	Discharged Points
8	20	Pass	All accessible points where contact discharge cannot be applied such as Displays, Indicators light, Keyboard, Button, Switch, Knob, Air gap, Slots, Hole and so on

Indirect Application of ESD

Horizontal Coupling Plane under the EUT

Applied Voltage (kV)	No. of Discharge for each point	Result (pursuant to EN 55014-2)	Discharged Point
4	20	Pass	At the front edge of each HCP opposite the centre point of each unit of the EUT

Vertical Coupling Plane beside the EUT

Applied Voltage (kV)	No. of Discharge for each point	Result (pursuant to EN 55014-2 criterion B)	Discharged Point
4	20	Pass	The centre of the vertical edge of the coupling plane

TEST REPORT

8.2 EN 61000-4-6(Pursuant to EN 55014-2) Injected Current (0.15 MHz to 230 MHz)

Performance criterion: A

Test Result: Pass

8.2.1 Block Diagram of Test Setup

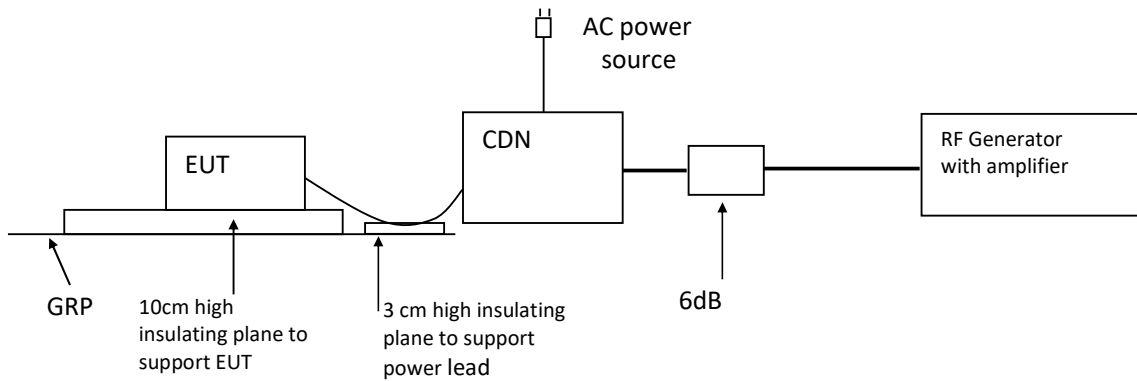

8.2.2 Test Setup and Procedure

The EUT was placed on an insulating support of 0.1m height above a ground reference Plane, arranged and connected to satisfy its functional requirement.

All relevant cables were provided with the appropriate coupling and decoupling devices at a distance between 0.1m and 0.3m from the projected geometry of the EUT on an insulating support of 0.03m height above the ground reference plane.

Test voltage was verified before each testing though power meter combined in the RF generator with AMP.

Dwell time was set to 3s and step was set as 1% to keep sufficient response time for EUT. The frequency from 0.15MHz to 230MHz was checked.

8.2.3 Test Result

Port:	Frequency (MHz)	Level (Pursuant to EN55014-2)	Result
A.C. Power Lines	0.15 to 230	3V (r.m.s.)	Pass
D.C. Power Lines	0.15 to 230	1V (r.m.s.)	N/A
Signal Lines	0.15 to 230	1V (r.m.s.)	N/A
Control Lines	0.15 to 230	1V (r.m.s.)	N/A

TEST REPORT

8.3 EN 61000-4-4(Pursuant to EN 55014-2) Electrical Fast Transient/Burst

Performance criterion: B

Test Result: Pass

8.3.1 Block Diagram of Test Setup

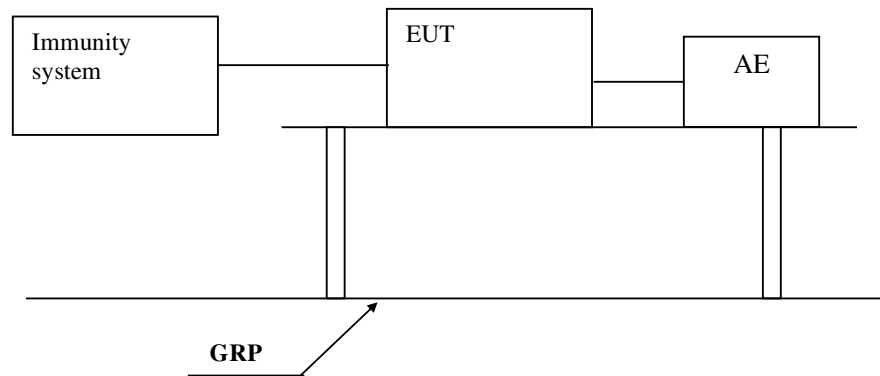

8.3.2 Test Setup and Procedure

The EUT was placed on a 0.1m high wooden table, standing on the ground reference plane 3m by 2m in size, made by steel 1mm thick.

The distance between the EUT and any other of the metallic surface except the GRP was greater than 0.5m.

The mains lead excess than 0.5m was folded to avoid a flat coil and situated at a distance of 0.1m above the ground reference plane to insure the distance between the coupling device and the EUT was 0.5m.

The EUT was arranged and connected to satisfy its functional requirement and supplied by the coupling-decoupling network.

8.3.3 Test Result

Level (Pursuant to EN55014-2)	Polarity	A.C. Power supply line and protective earth terminal	D.C. Power Lines, Signal Line & Control Line
0.5kV	+	N/A	N/A
0.5kV	-	N/A	N/A
1kV	+	Pass	N/A
1kV	-	Pass	N/A

TEST REPORT

8.4 EN 61000-4-5(Pursuant to EN 55014-2) Surge Immunity

Performance criterion: B
Test Result: Pass

8.4.1 Block Diagram of Test Setup

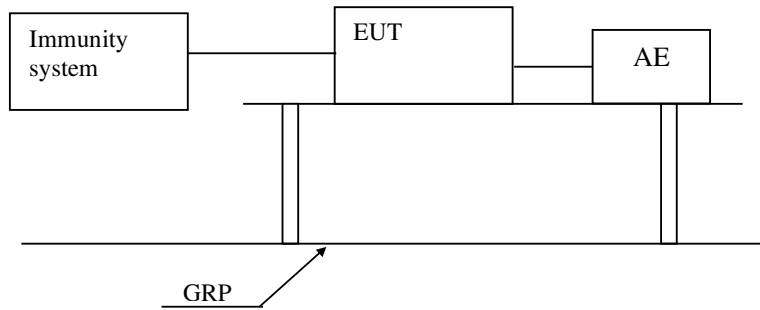

8.4.2 Test Setup and Procedure

The surge was applied to the EUT power supply terminals via the capacitive coupling network.

Decoupling networks were required in order to avoid possible adverse effects on equipment not under test that might be powered by the same lines and to provide sufficient decoupling impedance to the surge wave so that the specified wave might be developed on the lines under test.

The EUT was arranged and connected according to its functional requirements.

The EUT was placed on a 0.1m high wooden support above the GRP), supplied by the coupling-decoupling network, and arranged and connected to satisfy its functional requirement. The power cord between the EUT and the coupling/decoupling network was less than 2 meters.

8.4.3 Test Result

Level (Pursuant to EN 55014-2)	Result
Between Phase And Phase: 1kV	N/A
Between Phase And Neutral: 1kV	Pass
Between Phase And Earth: 2kV	N/A
Between Neutral And Earth: 2kV	N/A

TEST REPORT

8.5 EN 61000-4-11(Pursuant to EN 55014-2) Voltage Dips and Interruptions

Performance criterion: C
Test Result: Pass

8.5.1 Block Diagram of Test Setup

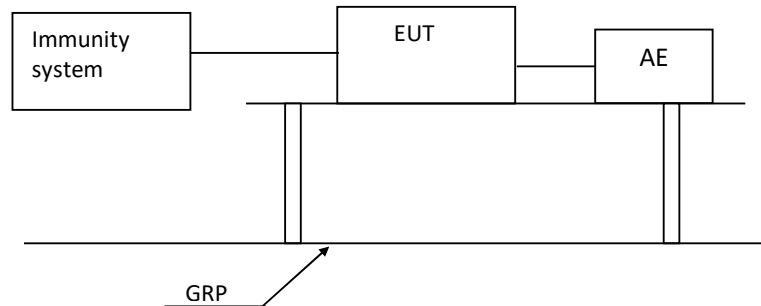

8.5.2 Test Setup and Procedure

The EUT was placed on an insulating support of 0.8m height, standing on a ground reference plane, and arranged and connected to satisfy its functional requirement

The test was performed with the EUT connected to the test generator with the shortest power supply cable as specified by the EUT manufacturer.

The EUT was tested for each selected combination of test level and duration with a sequence of three dips/interruptions with intervals of 10 s minimum. Each representative mode of operation was tested.

Abrupt changes in supply voltage was occur at zero crossings of the voltage.

8.5.3 Test Result

Test condition (Pursuant to EN 55014-2)				
Test Level in %U _r	50 Hz		60 Hz	
	Duration	Result	Duration	Result
0	0.5	Pass	0.5	Pass
40	10	Pass	12	Pass
70	25	Pass	30	Pass

Remark: UT is the rated voltage for the equipment.

TEST REPORT

8.6 EN 61000-4-3(Pursuant to EN 55014-2) Radiated Electromagnetic Field Immunity

Performance criterion: A

Test Result: **Not Applicable**

Remark:

Containing electronic control circuitry with no internal clock frequency or oscillator frequency higher than 15 MHz.

8.6.1 Block Diagram of Test Setup

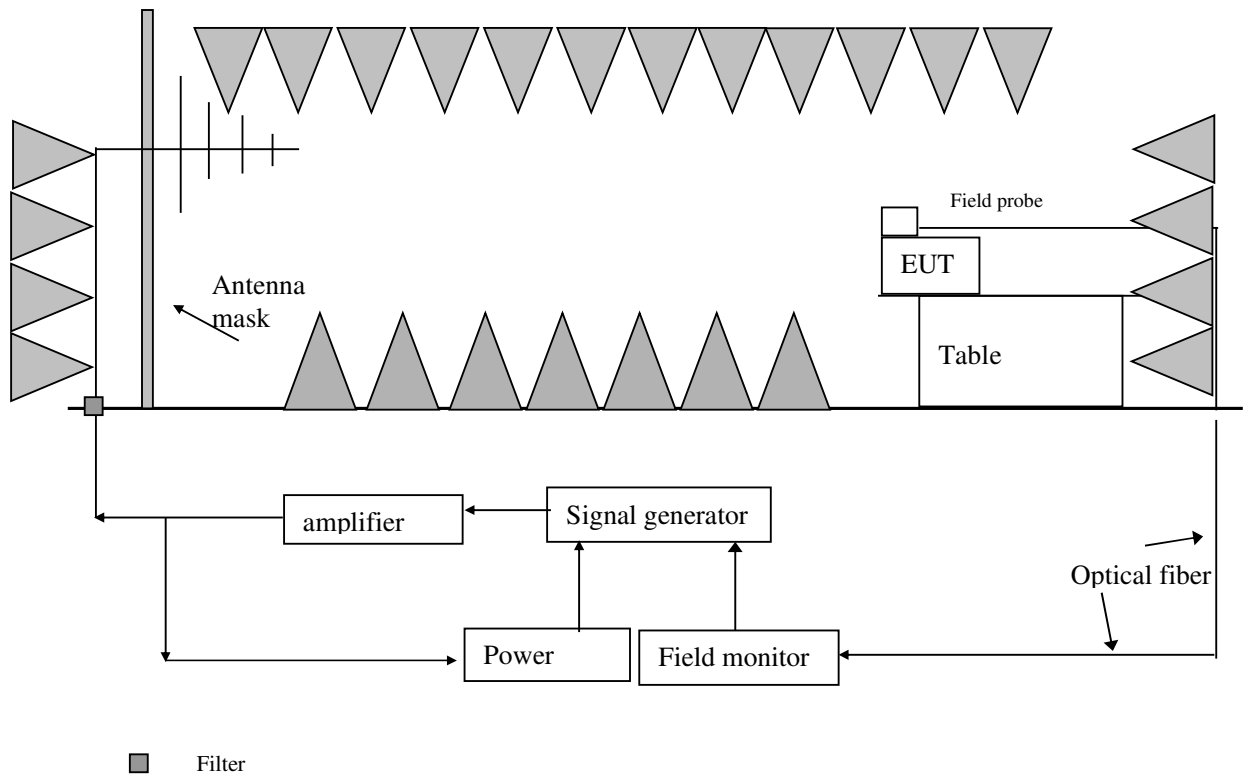

TEST REPORT

8.6.2 Test Setup and Procedure

The test was conducted in a fully anechoic chamber to maintain a uniform field of sufficient dimensions with respect to the EUT, and also in order to comply with various national and international laws prohibiting interference to radio communications.

The equipment was placed in the test facility on a non-conducting table 0.8m high (for floor standing EUT, is placed on a non-conducting support 0.1m height).

For all ports connected to EUT, manufacturer specified cable type and length was used, for those cables no specification, unshielded cable applied. Wire is left exposed to the electromagnetic field for a distance of 1m from the EUT. The EUT was arranged and connected according to its functional requirements

Before testing, the intensity of the established field strength had been checked by placing the field sensor at a calibration grid point, and with the field generating antenna and cables in the same positions as used for the calibration, the forward power needed to give the calibrated field strength was measured. Spot checks was made at a number of calibration grid points over the frequency range 80MHz to 1000MHz, both polarizations was checked.

After calibration, the EUT was initially placed with one face coincident with the calibration plane.

The frequency range is swept from 80 MHz to 1000 MHz at 3V/m EM field, with the signal 80% amplitude modulated with a 1 kHz sine-wave, pausing to adjust the r.f. signal level.

The dwell time at each frequency was 3s so as that the EUT to be exercised and be able to respond.

The step size was 1% of the fundamental with linear interpolation between calibrated points. Test was performed with the generating antenna facing each of the four sides of the EUT.

8.6.3 Test Result

Frequency (MHz)	Exposed Side	Field Strength (V/m)	Result
80 to 1000	Front	3V/m (r.m.s.)	Pass
80 to 1000	Left	3V/m (r.m.s.)	Pass
80 to 1000	Rear	3V/m (r.m.s.)	Pass
80 to 1000	Right	3V/m (r.m.s.)	Pass

TEST REPORT

9. APPENDIX I - PHOTOS OF TEST SETUP

Conducted Emission



Radiated Power



TEST REPORT

Clicks



EFT Immunity



TEST REPORT

ESD Immunity



Inject current immunity



TEST REPORT

Radiated EM field immunity



Surge and DIP Immunity



TEST REPORT

10. APPENDIX II – PHOTOS OF EUT



Overall view



Overall view

TEST REPORT



Bottom view

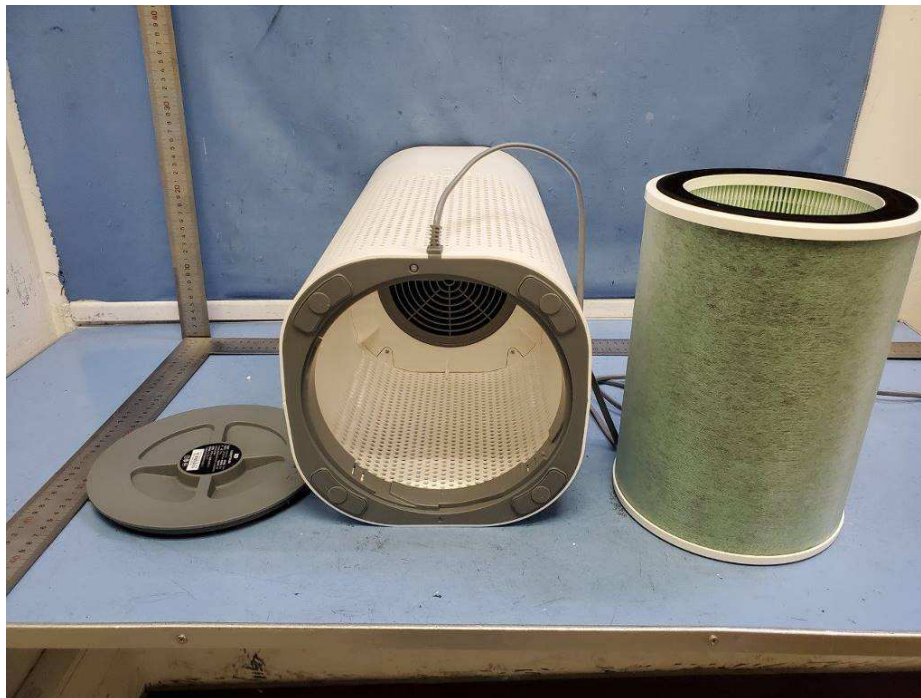

view of Remove filter

TEST REPORT



Bottom view inner view



supply cord anchorage

TEST REPORT



Hall sensor location

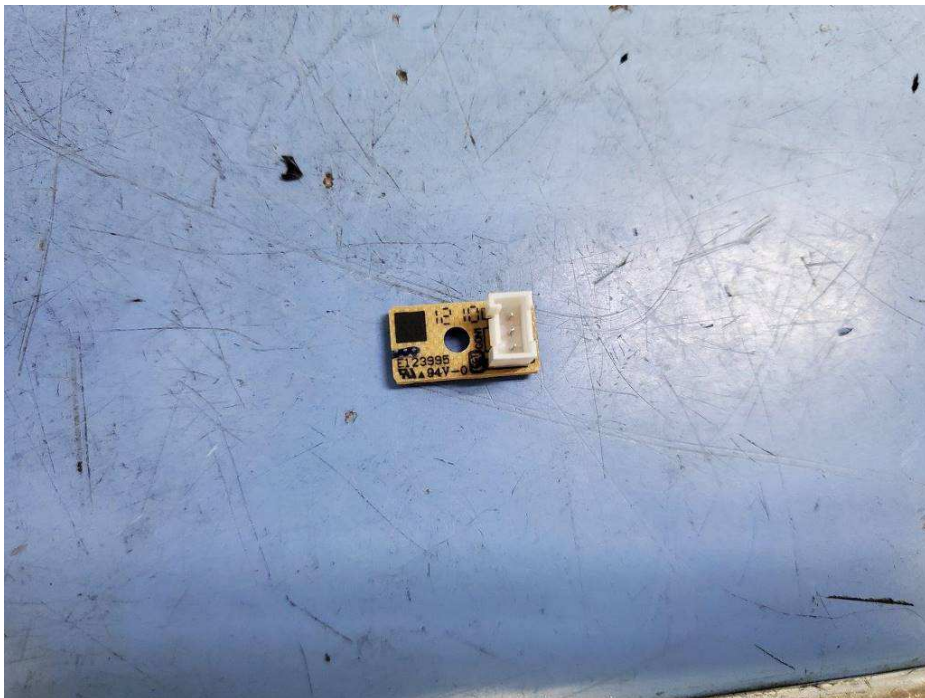

Hall sensor PCB

TEST REPORT



Hall sensor PCB



Inner view

TEST REPORT



Display PCB

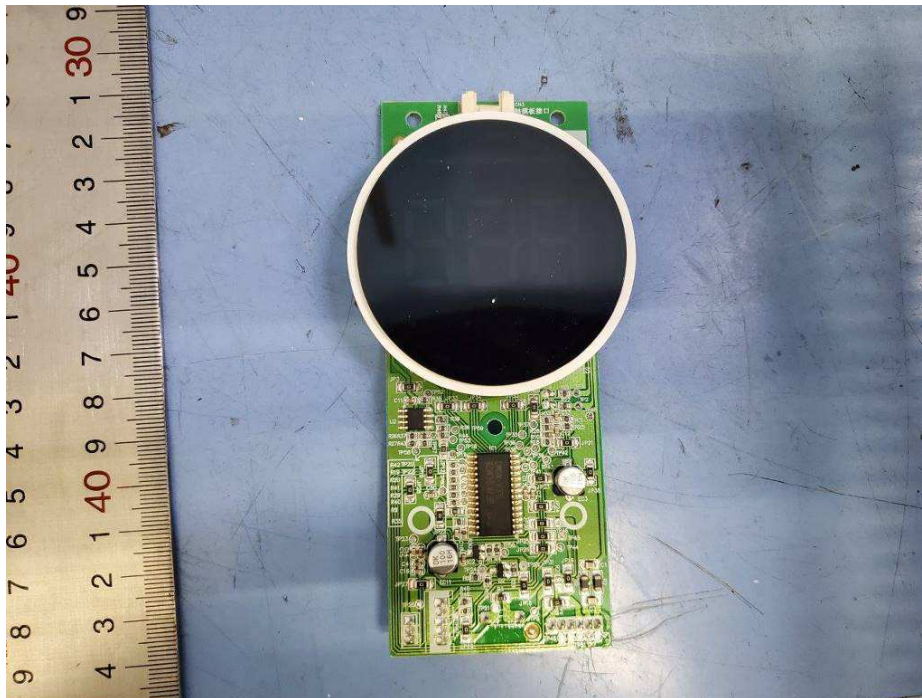

Display PCB

TEST REPORT



PM2.5 Sensor location

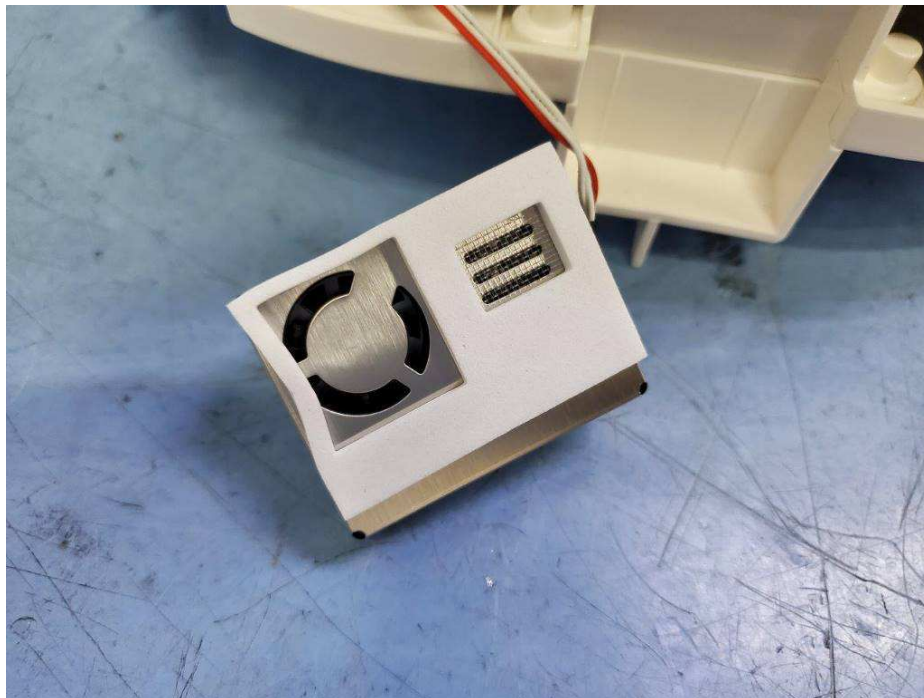

PM2.5 Sensor

TEST REPORT



PM2.5 Sensor

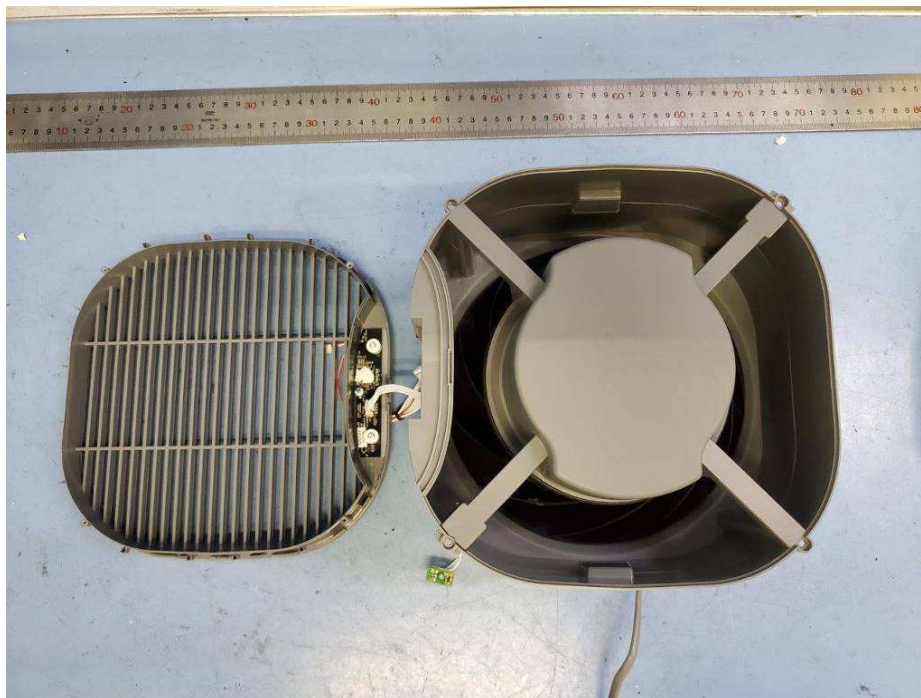

PCB Box

TEST REPORT

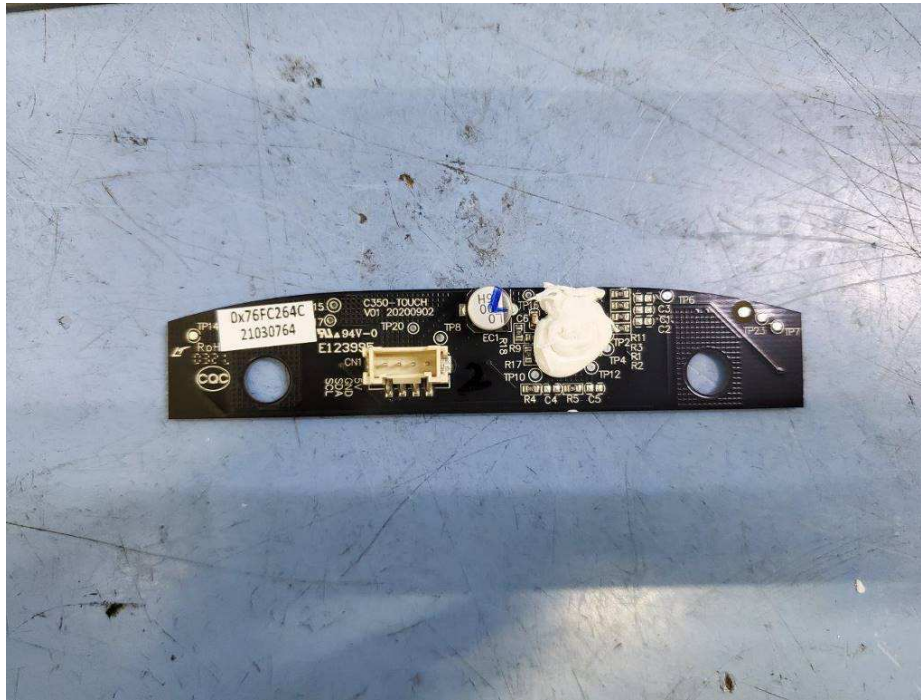

control PCB

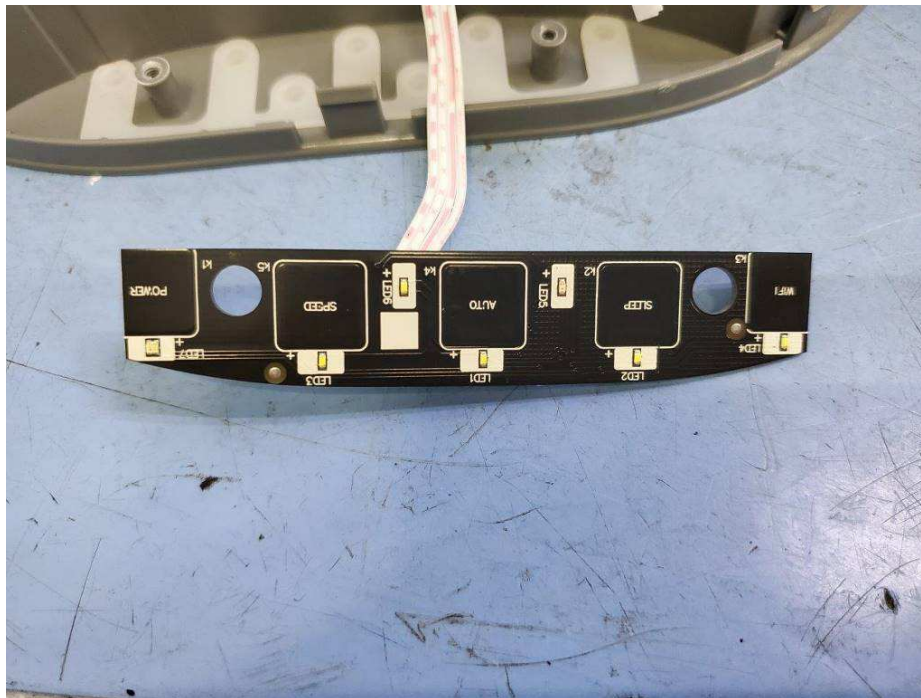

Front view of Control PCB

TEST REPORT

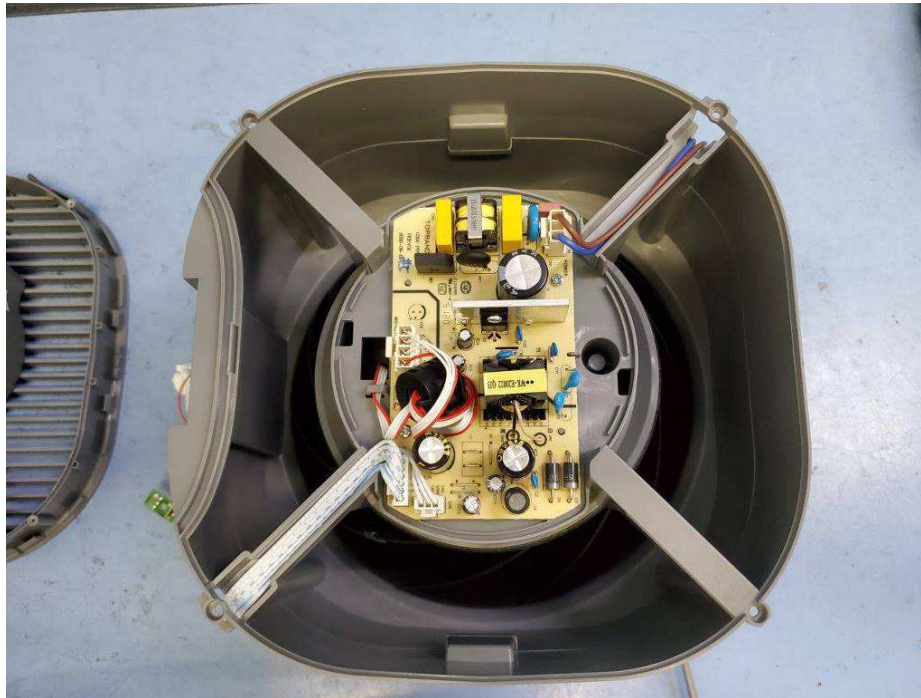

Front view of Power PCB

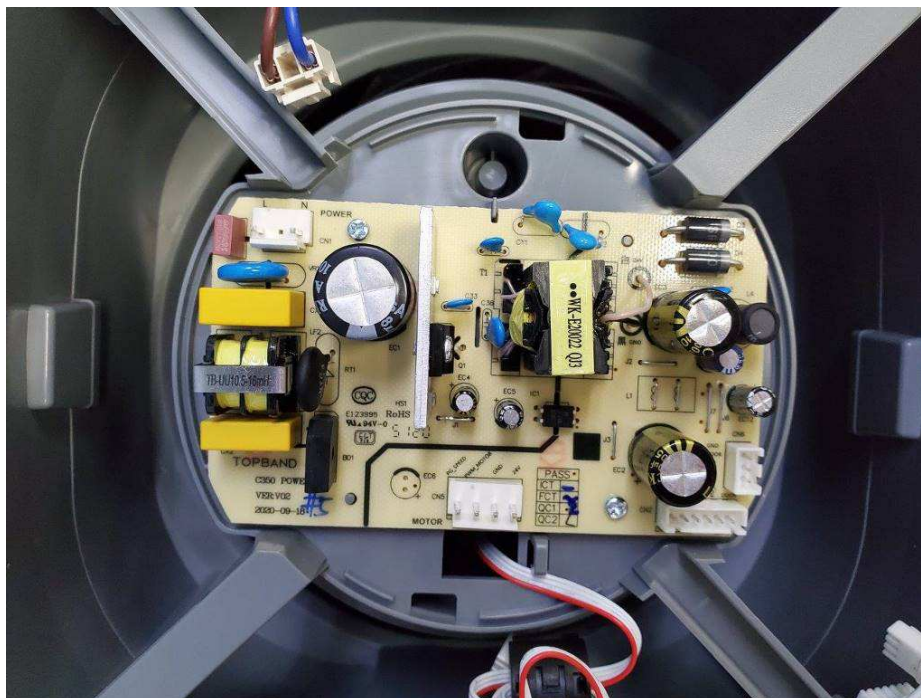

Power PCB

TEST REPORT

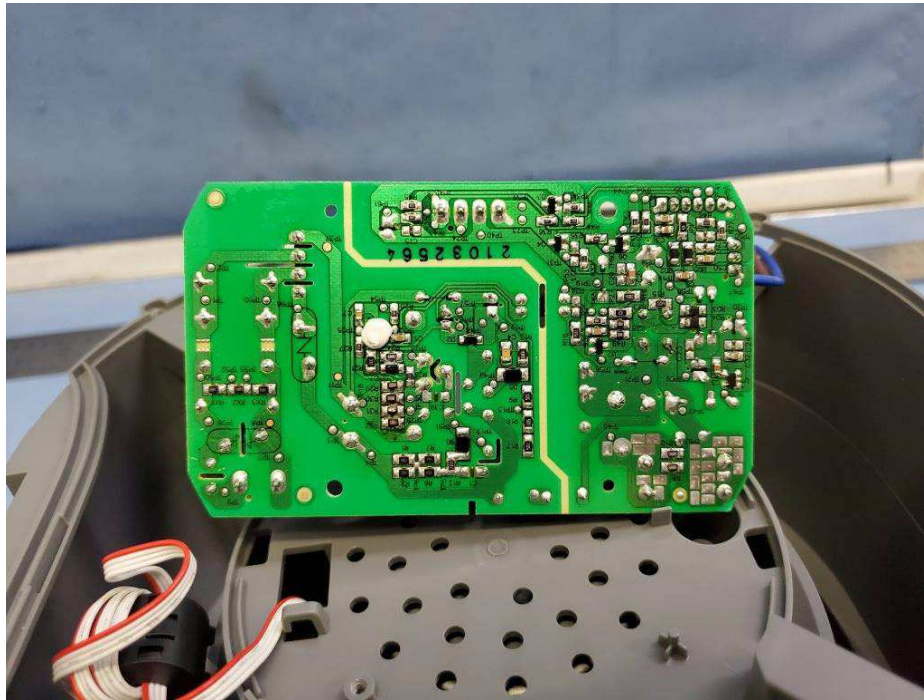

back view of Power PCB

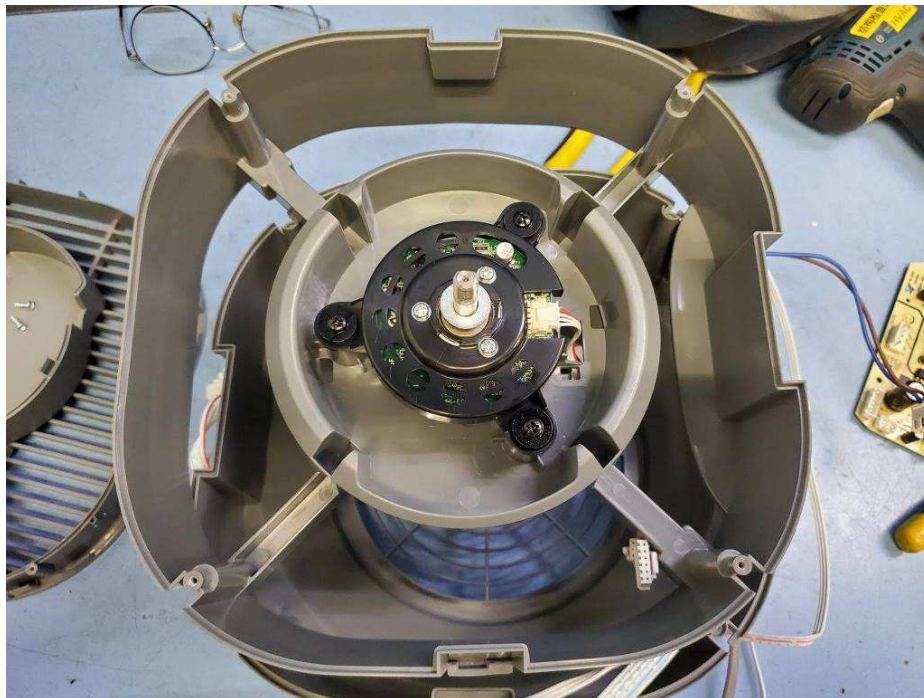

Fan Motor position

TEST REPORT



Fan Motor

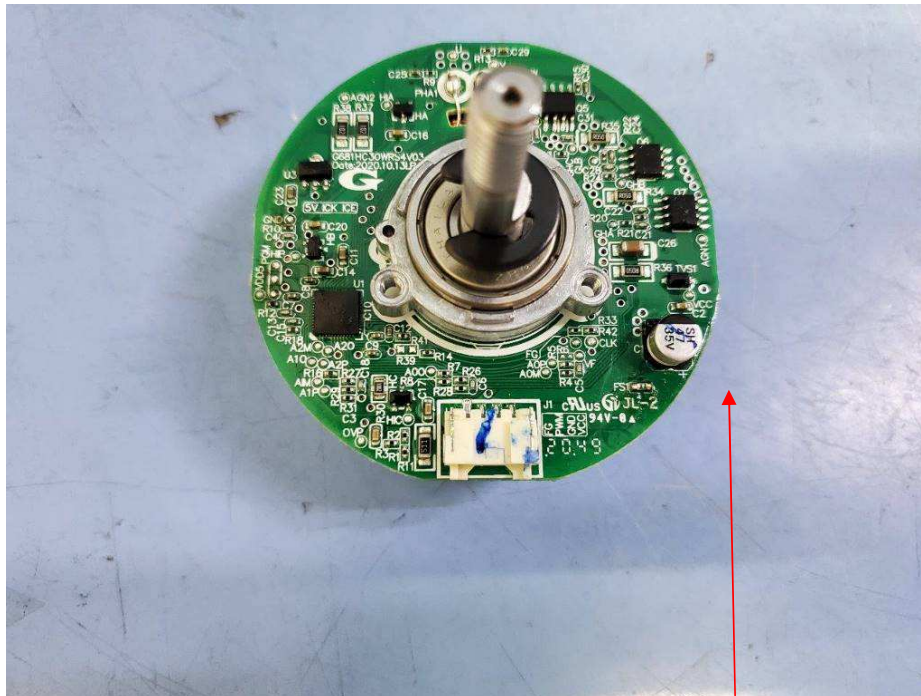

PCB for Fan Motor G0655KHV09, Fuse FS1

*****End of Report*****